



Program Description

Program Name: Professional* Certificate: Natural Gas Plant Operations

Course Fee: \$2999.00 (Check for promotions, if any, on our Home Page button: CURRENT PROMOTIONS)

Course Cost in Cost per Hour: \$8.00 per hour

Who is this course for?

This course is meant for people who seek an entry-level position in a natural gas processing facility. This course is based on US manufacturing and operational practices. Any person who can use email will be able to participate in this course – no additional skills are required. The course is designed to prepare a student for entry-level blue-collar jobs, where one routinely interfaces with industrial equipment. Keeping the entry-level qualification requirements in view, such jobs pay well. We specialize in creating and providing adult training of this nature – consistent with our slogan: *We Provide Industry-Readytm training using student-friendly methodologies.*

Course Benefits

This program offers some unique benefits. The main benefit: It increases the chances of a person with only Gr-12 education to get accepted into a high-paying job at an entry-level. There are hundreds of natural gas processing plants across the US – some very small and some very big. All of them require workers to manage manufacturing operations. Unfortunately, there are very few institutions that prepare workers for such work. Completion of this course will equip potential workers with highly focused work-place knowledge including safety, basic sciences, and the relevant technical knowledge – all in learned in an easy-to-learn format. These days, due to availability of modern technology and safety regulations, for such jobs most of the physical hard work has been replaced by machines that are operated by humans through computer interfaces; this allows men and women to be equally suitable to handle the work-place requirements.

After a person gets accepted into an entry-level position, the opportunities for advancement are abundant; depending upon personal work ethics and attitude toward learning, a worker can move into higher operational, maintenance or managerial positions. Most of such manufacturing facilities encourage in-house personnel to move up in supervisory and managerial ranks. Learn more about the nature of such jobs from our white paper (*High-Paying Jobs for High School Graduates*) available at our website: www.HoustonIndustrialTraining.com



1. Document Version: Rev Jan 01, 2016

2. Houston Industrial Training Institute is an IACET/ANSI ACCREDITED continuing education/training provider. More details provided at the end of the last page.



Course Structure

- a. The course provides industry-ready information in a manner that allows almost anyone, with any background to participate in it. Unlike regular classroom-based learning, this course allows a user to go over the learning materials a number of times and write the test a number of times – this approach results in exceptionally high quality of learning.
- b. The course is web-based and is delivered on-line; and it is completely self-standing. You are not required to buy any textbooks to take this course; also, no supplemental written material or books are provided to the student. All of the relevant material is embedded in the course.
- c. To augment learning, in many learning modules animations and simulations are provided – allowing students to interact with the learning materials and get a feeling for the dynamism of industrial systems.
- d. The course consists of a number of learning modules. Each of the modules consists of learning materials as well as a written test. To pass the course a student has to pass each of the modules. The pass mark is 75%. After going through the learning materials, the student is expected to email the answer sheets for evaluation.
- e. Where necessary, the online modules provide you with a listing of reference material – in case you want to build a personal library or want to do additional research. Again, you do not need to acquire the reference material to complete the course. You are allowed to print the online course material (via print screen) as long as you do so for your own personal use.

Note: Please do not share our course material with others and do not use it for any commercial use. Under all circumstances we maintain copyright to all of the material presented in the course.

Course Availability: Anytime, from anywhere. This is a totally web-based online course; prospective students may enroll at anytime from anywhere. Also, students can start and participate in the course at anytime from anywhere.

Course Pre-requisites: None. Our courses include all of the necessary math and science material relevant to the course. Any person who can use email will be able to participate in this course – no additional skills are required.

Standard Time to Complete Course:** 399 hours

Professional Development Hours (PDHs):** 399.0 hours

Continuous Education Units (CEUs): 39.9



1. Document Version: Rev Jan 01, 2016

2. Houston Industrial Training Institute is an IACET/ANSI ACCREDITED continuing education/training provider. More details provided at the end of the last page.



Access Allowed to the Course after Registration: 365 days

Instructor: Houston Industrial Training Institute Staff

7 Calendar Days, No Questions Asked Refund Policy

We are committed to provide a zero-risk learning opportunity for prospective students. To this end, we will issue a full refund on monies paid by a student if a refund is asked for within seven calendar days of payment. This applies to all monies paid during the preceding 7 calendar days. Please note that no refund is allowed if the completion certificate has been made available to the student or if more than three calendar days have passed.

How to Register: Visit our Home Page www.HoustonIndustrialTraining.com Please click on the REGISTER button located on the left hand panel. In addition, feel free to ask for clarifications and help by via email from: Registrar@HoustonIndustrialTraining.com. Additional informatory material is available via the How-To Guide button located on our Home Page.

Help for Registered Students: Students can ask for help at any time via email. Send an email to instructor@HoustonIndustrialTraining.com. In your email, please include your name, your Student Code, your course name, your phone number and your email address. We aim is to respond to students within two working days.

Third Party Commercial Interest Disclosure Policy

We do not allow anyone, including the instructors, to solicit any business from the students other than HITI products. Further, no instructor is allowed to present any third party products or software or events to the students. HITI does not allow any third-party compensation related to the learning events or programs. Ask for HITI Policy 25 for details on this subject.

Required Equipment

1. An ordinary PC (not older than five years).

Note: We do not test our courses on computers other than PC. If your computer is not a PC, we encourage you to take our FREE sample course to ensure your hardware is compatible with our delivery system. It is rare when our courses do not work on non-PC computers. We ask you to do this test BEFORE registering for the course.

2. A good Internet connection. We design most of our instruction pages to download in less than five seconds. Some of the graphics-heavy pages may take longer to download.



1. Document Version: Rev Jan 01, 2016

2. Houston Industrial Training Institute is an IACET/ANSI ACCREDITED continuing education/training provider. More details provided at the end of the last page.



3. Adobe Flash Player. Almost all PCs come equipped with this Flash Player. If your computer does not have it, you can download it for free from www.adobe.com.

Notes:

*The term Professional Certificate indicates an initial qualification that leads to a professional vocation, but does not lead to higher education such as an engineering degree.

** Note: The course consists of a number of Learning Modules – all listed below with the standard completion time. The completion-hour number shown here is the sum of standard completion time for all of the modules. The standard learning-module completion time is based on the average of time taken by actual or study-group students, or our estimate. The standard module-completion time assessment excludes breaks of any kind. Depending upon the experience and educational background of a particular student, the actual time taken by a particular student may vary by a wide margin from what is noted here. We give credit for PDHs and CEUs per information provided in this document, and NOT the actual time taken by a particular student.

Professional Development Hours (PDHs) are equal to the standard learning-module completion time. The corresponding Continuing Education Units (CEUs) are obtained by dividing the standard time by ten.

Listing of included Learning Modules

Basic Industrial Safety

Standard Time to Complete: 6 hours

Learning Outcomes

On successful completion of this learning module, you will be able to:

1. **DESCRIBE** why paying attention to safety is important in an industrial plant.
2. **DESCRIBE** employer and employee responsibilities in reference to personnel safety.
3. With reference to an industrial plant, **IDENTIFY** common hazards and possible protection against them.
4. **EXPLAIN** why special attention is paid to hazards associated with Hydrogen Sulfide gas.
5. **DESCRIBE** safety hazards posed by electricity, confined spaces and toxic gases.
6. **SELECT** basic protective equipment for common hazards in an industrial plant.



1. Document Version: Rev Jan 01, 2016

2. Houston Industrial Training Institute is an IACET/ANSI ACCREDITED continuing education/training provider. More details provided at the end of the last page.

Basic Hazard Communication

Expected Time to Complete: 10 hours

Learning Outcomes

On successful completion of this learning module, you will be able to:

1. **DESCRIBE** the purpose and the key elements of the Federal Hazard Communication Standard (HCS.) You will also be able to IDENTIFY other common names used to refer to this standard.
2. **DESCRIBE** how a hazardous chemical is identified in a workplace.
3. **DESCRIBE** the purpose and what is meant by the term MSDS. You will also be able to describe the key elements of an MSDS. Using MSDSs, you will also be able to **SELECT** appropriate protective measures when handling chemicals.
4. **DESCRIBE** the nature of the NFPA and HMIS/HMIG hazard communication methods. You will also be able to DESCRIBE what is meant by the terms TLV, PEL, TWA, Acute Effect, Acute Toxicity, Chronic Effect, Chronic Toxicity, Carcinogen, Flammable Liquid, Combustible Liquid, and Chemical Reactivity.
5. **DESCRIBE** the nature of the DOT methods for hazard chemical identification.
6. **DESCRIBE** the necessary training activities required to comply with the Federal Communication Standard (HCS.)



Basic Lockout-Tagout

Standard Time to Complete: 10 hours

Learning Outcomes

On successful completion of this learning module, you will be able to:

1. **DESCRIBE** the key reasons for implementation of lockout-tagout procedures.
2. **DESCRIBE** what is meant by the term “energized equipment.” You will be able to list various ways by which equipment “energized state” can occur.
3. **DESCRIBE** under what conditions lockout-tagout procedures are required. You will also be able to **DESCRIBE** the employer’s responsibilities for implementation of such procedures.
4. **DESCRIBE** the training requirements prescribed by OSHA for lockout-tagout procedures. You will also be able to DESCRIBE the prescribed worker training requirements under OSHA’s regulations.





5. **DESCRIBE** the key items that need to be considered for electric power lockout-tagout systems. In reference to the electrical requirements, you will be able to **DESCRIBE** what is meant by the term “qualified employees;” you will also be able to **DESCRIBE** the responsibilities of such employees.

6. **DESCRIBE** the ten general procedural steps, outlined in the learning module, for implementation of Lockout-Tagout Procedure.

Math for Technicians and Operators

Standard Time to Complete: 20 hours

Learning Outcomes

On successful completion of this learning module, you will be able to:

1. **ADD, MULITPLY, DIVIDE, and SIMPLIFY** fractional numbers; you will also be able to **ADD, MULITPLY, DIVIDE, and SIMPLIFY** decimal numbers; you will also be able to **CONVERT** fractional numbers into decimal numbers and vice versa.
2. **CALCULATE** areas and volumes of simple figures.
3. **MANIPULATE** and **WORK WITH** simple equations.
4. **CREATE** graphical representations of two-dimensional numeric relationships.
5. **CALCULATE** percentage values of simple quantities.
6. **CONVERT** one measurement unit into another measurement unit.

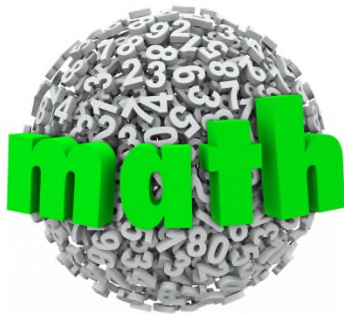

Physics for Technicians 1

Standard Time to Complete: 20 hours

Learning Outcomes

On successful completion of this learning module, you will be able to:

1. **DESCRIBE** what is meant by the English and the SI measurement systems. You will also be able to **STATE** some common conversion factors.
2. **DESCRIBE** what is meant by the terms: mass, weight, matter, weight density, and specific gravity.
3. **DESCRIBE** what is meant by the terms: Buoyancy, and Archimedes’ principle.



1. Document Version: Rev Jan 01, 2016

2. Houston Industrial Training Institute is an IACET/ANSI ACCREDITED continuing education/training provider. More details provided at the end of the last page.

4. **DIFFERENTIATE** between heat and temperature. You will also be able to **DESCRIBE** the following concepts: Fahrenheit scale, Celsius scale, Rankine scale, and Kelvin scale. You will also be able to **CONVERT** a given temperature in any scale to any of the three other scales.

5. **DIFFERENTIATE** between the terms sensible heat and latent heat. You will also be able to **DESCRIBE** the terms: thermal conductivity, heat convection, heat radiation, and heat conduction.

6. **DESCRIBE**, using latent heat concepts, how water at room temperature is converted into superheated steam.

Physics for Technicians 2

Standard Time to Complete: 20 hours

Learning Outcomes:

On successful completion of this learning module, you will be able to:

1. **DESCRIBE** the meaning of and **DIFFERENTIATE** between the terms: Mass, weight, and energy. You will also be able to **DIFFERENTIATE** between various types of energy such as potential energy, kinetic energy, electrical energy, thermal energy, etc.

2. **DESCRIBE** how pressure is exerted by various forms of matter, and **DIFFERENTIATE** between various forms of pressure measuring units such as psig, psia, inches of water, head, inches of mercury – pressure, inches of mercury – vacuum, etc.

3. **DESCRIBE** how gases exert pressure. You will also be able to **DESCRIBE** the three gas laws, including the ability to use the formula $PV=RT$ to calculate any of the variables, provided the other variables are given.

4. **DESCRIBE** how liquids exert pressure and what is meant by static pressure and how it varies according to the liquid depth.

5. **DESCRIBE** the nature of a manometer and how it can be used to measure pressure and vacuum.

6. **DESCRIBE** what is meant by the term “Vapor Pressure” and how it varies with liquid temperature.

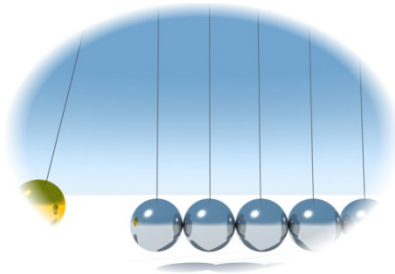

Physics for Technicians 3

Standard Time to Complete: 40 hours

Learning Outcomes:

On successful completion of this learning module, you will be able to:

1. **DESCRIBE** what is meant by the terms: Work, Energy and Power; also **DESCRIBE** how these concepts relate to each other.
2. **DESCRIBE** what is meant by the term Force Transformers; also **DIFFERENTIATE** between different classes of levers, and **ANALYZE** to **IDENTIFY** similarities and differences between levers and pulleys.
3. **DESCRIBE**, in terms of electron flow, how electric current flows. You will also be able to **DESCRIBE** what forces the current to flow.
4. **DESCRIBE** how electromotive force (EMF) can be generated in a number of different ways.
5. **DESCRIBE** how alternating current (AC) is generated. You will also be able to **DIFFERENTIATE** between alternating current (AC) and direct current (DC.)
6. **SOLVE** simple numerical problems relating to electric circuits. You will also be able to **DESCRIBE** what is meant by the term “electric power” and how to **CALCULATE** it.

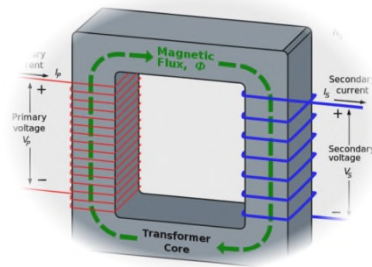

Electrical Safety

Estimated Time to Complete: 20 hours

Learning Outcomes

On successful completion of this learning module, you will be able to:

1. **IDENTIFY** the key components of a basic electric circuit. You will also be able to **EXPLAIN** the function of key components of a basic electric circuit.
2. **DESCRIBE** the common hazards posed by electricity. You will also be able to **STATE** the protective measures that should be taken by workers and electricians.
3. **DESCRIBE** what is meant by the term “grounding,” and how it is accomplished.
4. **DESCRIBE** how an improperly grounded system can become hazardous for workers.
5. **DESCRIBE** how a properly grounded system works and provides safety for workers and electricians. You will also be able to **DIFFERENTIATE** between a Service Ground and an Equipment Ground.



1. Document Version: Rev Jan 01, 2016

2. Houston Industrial Training Institute is an IACET/ANSI ACCREDITED continuing education/training provider. More details provided at the end of the last page.

6. **DESCRIBE** how a Ground Fault Current Interrupter (GFCI) works and provides safety.

Electricity for Technicians

Expected Time to Complete: 40 hours

Learning Outcomes

On successful completion of this learning module, you will be able to:

1. **DESCRIBE** the basic principles of electromagnetism and magnetic induction.
2. **PERFORM** calculations for simple electric circuits. For example, calculation of current in an electric circuit that has following parameters:
 - a. The circuit is provided with two opposing batteries of voltage ratings 20 volts and 5 volts.
 - b. The circuit consists of two resistors connected in parallel, one rated at 20 ohms and the other at 15 ohms.
3. **DIFFERENTIATE** between AC and DC. You will also be able to describe the following terms: Wavelength, period, amplitude, root mean square value and amplitude.
4. **DESCRIBE** how AC is generated. You will also be able to **DESCRIBE** Fleming's Right Hand Rule and the Left Hand Rule.
5. **DIFFERENTIATE** between the following types of faults: phase to phase, phase to neutral, and a 3-phase fault.
6. **DESCRIBE** the function of the terms related to a power distribution system: Transmission line, power transformer, power circuit breaker, high voltage fuses and high voltage capacitors. You will also be able to **DIFFERENTIATE** between a wound rotor induction motor and a squirrel cage induction motor.

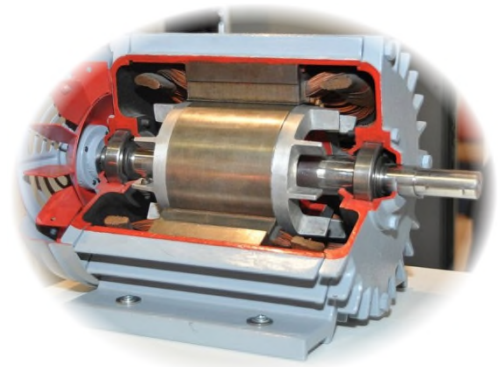

Fundamentals of Mechanical Seals

Expected Time to Complete: 10 hours

Learning Outcomes:

On successful completion of this learning module, you will be able to:

1. **DESCRIBE** the purpose of mechanical packings and mechanical seals.
2. **DESCRIBE** how a mechanical packing works.
3. **DESCRIBE** the common nomenclature associated with a basic mechanical seal.
4. **DESCRIBE** how a mechanical seal works.
5. **DIFFERENTIATE** between internal and external mechanical seals.
6. **DESCRIBE** key differences between application of mechanical seals and mechanical packings.

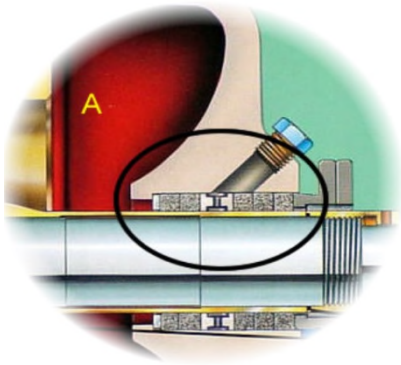

Basic Industrial Lubrication

Expected Time to Complete: 10 hours

Learning Outcomes

On successful completion of this learning module, you will be able to:

1. **DESCRIBE** the main purpose of industrial lubrication.
2. **DIFFERENTIATE** between different lubrication regimes – hydrodynamic lubrication, mixed film lubrication and boundary lubrication.
3. **DESCRIBE** main characteristics of lubricants, such as viscosity, specific gravity, pour-point, oxidation resistance, shear stability, flash-point, etc.
4. **IDENTIFY** different types of bearings used in the industry.
5. **IDENTIFY** different types of lubrication systems. You will also be able to **MATCH** a lubricant to field service conditions.
6. **DESCRIBE** main operator-functions pertaining to equipment lubrication.

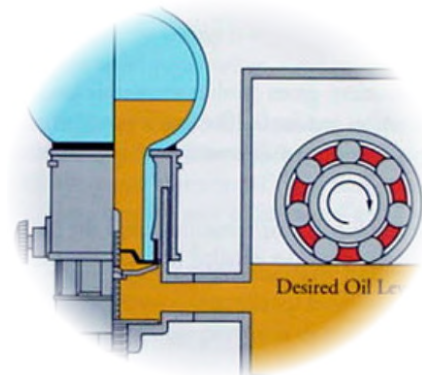

Process Industry Valve Fundamentals

Expected Time to Complete: 20 hours

Learning Outcomes

On successful completion of this learning module, you will be able to:

1. **DESCRIBE** the key components of common industrial valves: gate, globe, ball, butterfly, and plug.
2. **DIFFERENTIATE** between operational aspects of a gate valve and a globe valve.
3. **IDENTIFY** different types of closing elements used in gate valves.
4. **DESCRIBE** various flow characteristics of control valves such as linear, equal percentage, fast opening, and slow opening.
5. **DESCRIBE** some common ratings marked on the body of industrial valves.
6. **DESCRIBE** common operational and maintenance practices suitable for industrial valves.



Heat Exchanger Fundamentals

Estimated Time to Complete: 10 hours

Learning Outcomes

On successful completion of this learning module, you will be able to:

1. **DESCRIBE** the purpose and operational principles of cooling towers.
2. **DESCRIBE** (in reference to cooling towers) the meaning of the terms: Approach, distribution system, drift, evaporation loss, fill, flume, heat load, range, stack effect, crossflow design and counterflow design.
3. **DIFFERENTIATE** between the wet-bulb temperature and the dry-bulb temperature.
4. **DIFFERENTIATE** between the Atmospheric Cooling Towers, the Induced Draft Cooling Towers and the Forced Draft Cooling Towers.
5. **DESCRIBE** (in reference to the shell and tube type heat exchangers) the meaning of the terms: Baffles, channel head, counterflow, crossflow, fixed head, floating head, fouling, reboiler, tubesheet, tubeside and shellsided.
6. **DESCRIBE** the operational principles of a plate type heat exchanger.





1. Document Version: Rev Jan 01, 2016

2. Houston Industrial Training Institute is an IACET/ANSI ACCREDITED continuing education/training provider. More details provided at the end of the last page.

Compressed Air Fundamentals

Expected Time to Complete: 10 hours

Learning Outcomes

On successful completion of this learning module, you will be able to:

1. **DESCRIBE** the compressed air system classification system; you will also be able to **DESCRIBE** common compressed air applications.
2. **DESCRIBE** what is meant by the term “air humidity.” You will also be able to **DESCRIBE** the relationship between air moisture content and air temperature and pressure.
3. **DESCRIBE** advantages of multistage compression systems. You will also be able to **DESCRIBE** the role of intercoolers and aftercoolers. You will also be able to **DESCRIBE** how multistage air compression is executed.
4. **DESCRIBE** what is meant by the term “dew point,” and why it is controlled. You will also be able to **DESCRIBE** how dew point in compressed air systems is lowered.
5. **IDENTIFY** main types of air compressors; you will also be able to **DESCRIBE** how single-acting and double-acting compressors operate.
6. **DESCRIBE** the basic function and operation of typical air dryers.

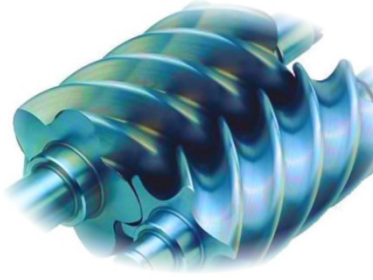

Introduction to Industrial Pumps

Expected Time to Complete: 5 hours

Learning Outcomes

On successful completion of this learning module, you will be able to:

1. **DESCRIBE** the key components of a basic centrifugal pump.
2. **DESCRIBE** how a centrifugal pump converts mechanical energy (supplied by the prime mover) into energized water. Here the term “energized” implies an increase in the energy content of water as it flows through a pump.
3. **DIFFERENTIATE** between the key operational aspects of centrifugal pumps and positive displacement pumps.
4. **DESCRIBE** how a double-acting reciprocating pump works.
5. **DESCRIBE** how gear pumps and diaphragm pumps work.
6. **DESCRIBE** the main operator functions regarding custodianship of centrifugal pumps.

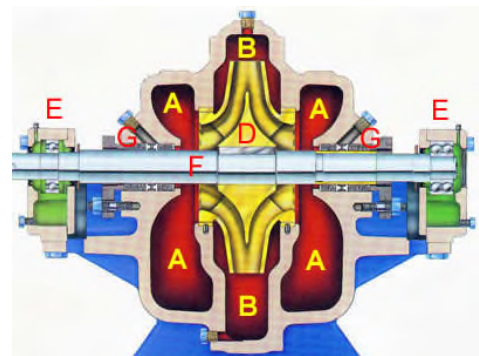

Centrifugal Pump Operation

Standard Time to Complete: 20 hours

Learning Outcomes

On successful completion of this learning module, you will be able to:

1. **DESCRIBE** different types of centrifugal pumps.
2. **DESCRIBE** what is meant by the term “priming”, and how self-priming pumps work.
3. **DESCRIBE** how a multistage centrifugal pump works.
4. **DESCRIBE**, in reference to centrifugal pumps, what is meant by “Suction Lift” and “Suction Head.”
5. **DESCRIBE** starting procedures for centrifugal pumps with various piping configurations on the suction side.
6. **IDENTIFY** and take **CORRECTIVE** action for common operational problems associated with centrifugal pumps.

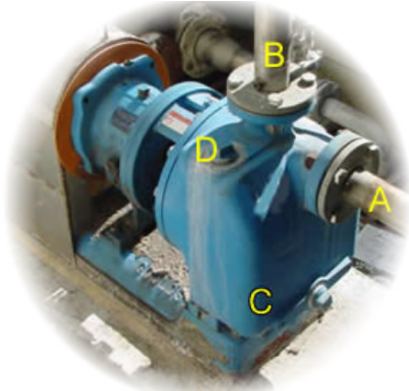

Reading Technical Drawings

Standard Time to Complete: 20 hours

Learning Outcomes

On successful completion of this learning module, you will be able to:

1. **READ** and **IDENTIFY** symbols for pressure instruments such as pressure transmitters, pressure sensors, pressure control valves and pressure control loops.
2. **READ** and **IDENTIFY** symbols for temperature instruments such as temperature transmitters, temperature sensors, temperature control valves and temperature control loops.
3. **READ** and **IDENTIFY** symbols for flow instruments such as flow transmitters, flow sensors, flow control valves and flow control loops.
4. **READ** and **UNDERSTAND** Process Flow Diagrams (PFDs).
5. **READ** and **UNDERSTAND** Process Block Diagrams.
6. **READ** and **UNDERSTAND** Piping and Instrument Diagrams (P&IDs).

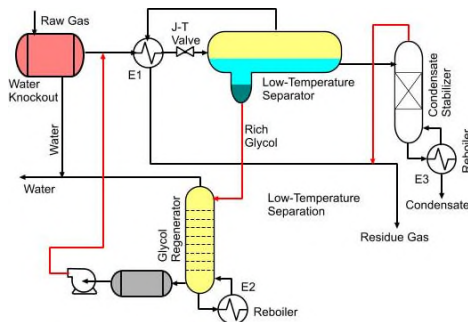

Basic Process Instrumentation and Control

Standard Time to Complete: 40 hours

Learning Outcomes

At the completion of this course you will be able to:

1. **DIFFERENTIATE** between manual and automatic control systems. You will also be able to **DESCRIBE** what the following terms mean: setpoint, process variable, primary element, final element, and indicating controllers.
2. **DESCRIBE** the operation of control loops pertaining to flow, pressure, temperature and pressure.
3. **DESCRIBE** how a manometer works. You will also be able to **DESCRIBE** how a displacement-type level monitoring system works.
4. **DESCRIBE** the relationship between the liquid density and the static pressure at the bottom of a tank.
5. **DESCRIBE** functions of components of the faceplate of a simple controller. You will also be able to **DIFFERENTIATE** between acceptable and unacceptable dynamic response of a controller.
6. **DIFFERENTIATE** between direct and indirect level measuring systems. You will also be able to **DESCRIBE** how a cascaded control system works.

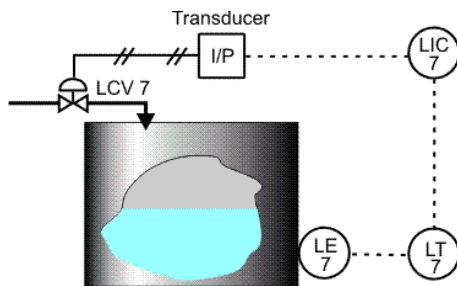

NaturalGas1000 – Natural Gas Fundamentals

Standard Time to Complete: 8 hours

Learning Outcomes

On successful completion of this learning module, you will be able to:

1. **DIFFERENTIATE** between natural gas as extracted from gas wells, and natural gas that is supplied to residential users.
2. **DESCRIBE** the natural geological phenomenon that creates natural gas in deep underground reservoirs.
3. **DESCRIBE** the measurement units commonly used for measurement of natural gas.
4. **DESCRIBE** and **COMPARE** emissions created by burning of oil, coal and natural gas.
5. **DESCRIBE** what is meant by the terms: acid gas; associated

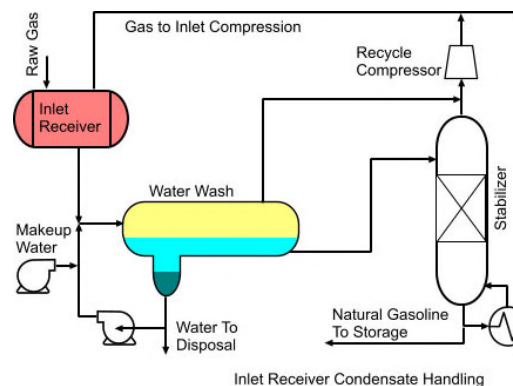



gas; condensate (as it relates to natural gas); dry natural gas; LNG; NGLs, natural gasoline; sour gas and sweet gas.

6. **DESCRIBE** what is meant by the terms: natural gas reservoir; deep natural gas; tight natural gas; shale gas and methane hydrates.

NaturalGas2000 – Natural Gas Processing

Standard Time to Complete: 60 hours

Learning Outcomes

On successful completion of this learning module, you will be able to:

1. **DESCRIBE** the significance and meaning of: hydrocarbon dew point; hydrates; natural gas condensate; difference between natural gas condensate and natural gas liquids (NGLs.)

2. **EXPLAIN** the operation of a complete natural gas processing system which may be used to process raw natural gas from gas wells into Sales Gas, ethane, propane, butane and pentane.

3. **DESCRIBE** how an indirect heater is used downstream of a raw natural gas choke.

4. **DESCRIBE** how a vertical two-phase separator works. Also, you will be able to **COMPARE** vertical two-phase separators with horizontal two-phase separators.

5. **DESCRIBE** how an Inlet Receiver Condensate Handling system works. Also, you will be able to **DESCRIBE** how an Absorption Process works for natural gas dehydration.

6. **DESCRIBE** how Joule-Thompson Effect works. You will also be able to **DESCRIBE** how a Low-Temperature Separation Process works.

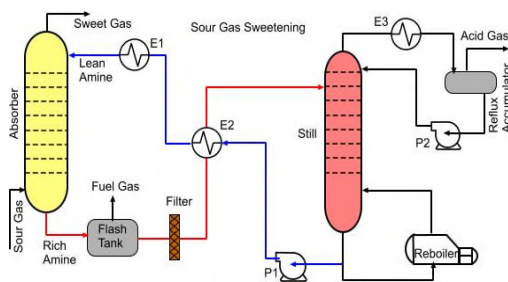

Copyright



1. Document Version: Rev Jan 01, 2016

2. Houston Industrial Training Institute is an IACET/ANSI ACCREDITED continuing education/training provider. More details provided at the end of the last page.



Houston Industrial Training Institute owns copyright and all rights to the material presented on its site or in its courses. Care is taken to mention credits and copyrights of other parties, where necessary. If an omission is encountered, please email necessary information to registrar@HoustonIndustrialTraining.com for immediate consideration.

Course Accreditation



Houston Industrial Training Institute has been approved as an Authorized Provider by the International Association for Continuing Education and Training (IACET), 1760 Old Meadow Road, Suite 500, McLean, VA 22102. In obtaining this approval, HITI has demonstrated that it complies with the ANSI/IACET 1-2007 Standard which is widely recognized as the Standard of good practice internationally. As a result of their Authorized Provider membership status, HITI is authorized to offer IACET CEUs for its programs that qualify under the ANSI/IACET 1-2007 Standard."

Information: Registrar@HoustonIndustrialTraining.com; Phone: 800-610-8486; Fax: 866-490-7959. Mail: 5348 Vegas Drive, Suite 998, Las Vegas, Nevada, 89108. For latest information on how to contact us, please go to our web-page HoustonIndustrialTraining.com and click on the **Contact Us** button.



1. Document Version: Rev Jan 01, 2016
2. Houston Industrial Training Institute is an IACET/ANSI ACCREDITED continuing education/training provider. More details provided at the end of the last page.